

Figure 2. Cutting plan for Floor framing

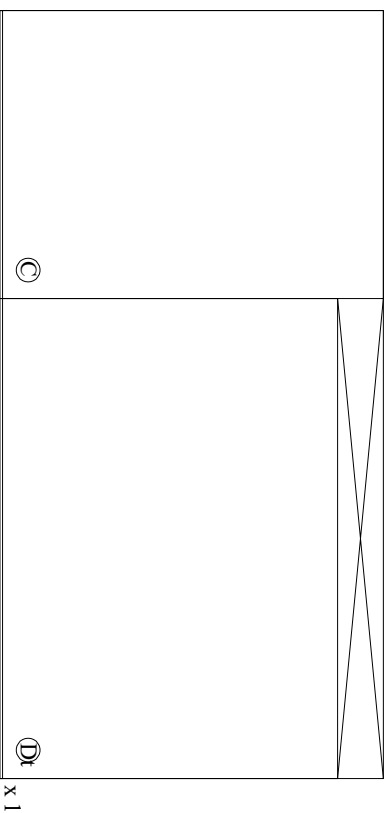

Figure 3. Marking and drilling plan for Floor framing

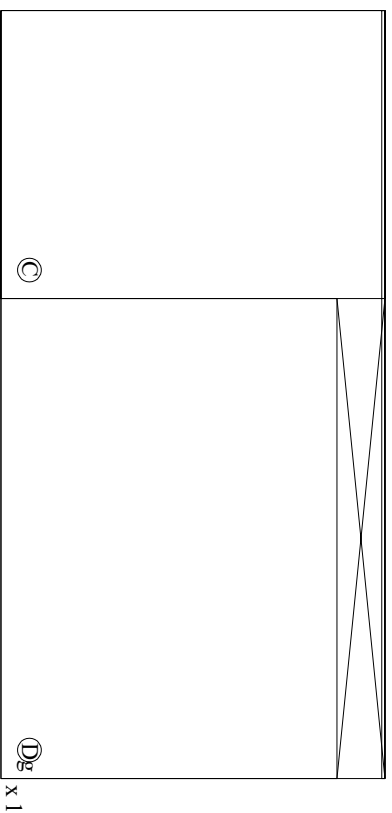

Figure 8. Floor and roof cutting plan

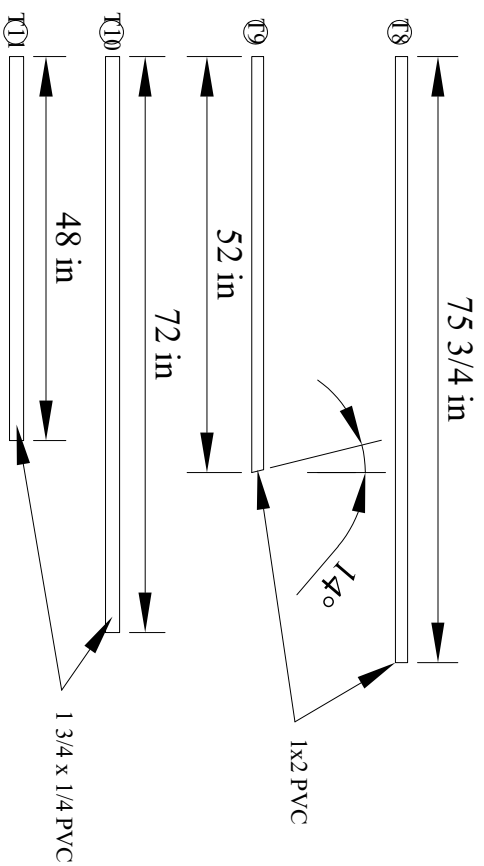

Figure 1e. Other trim components

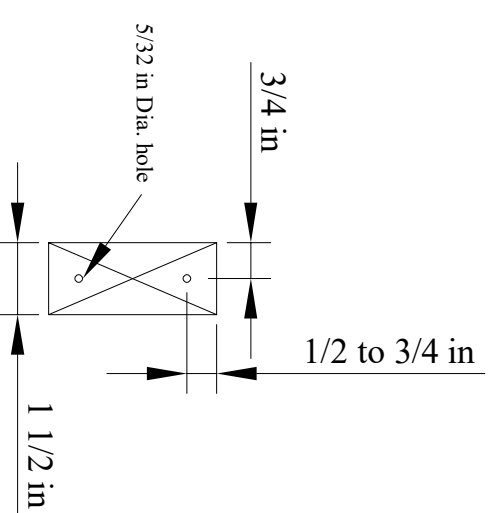

Figure 3a. Drilling key

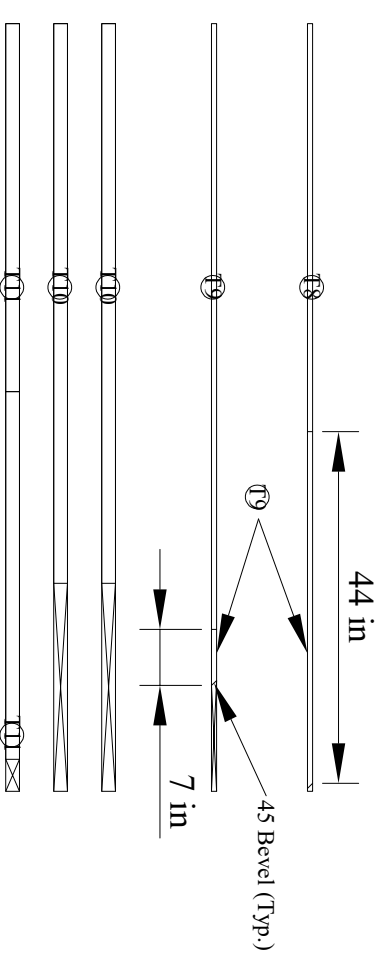

Figure 14b. Other trim components cutting plan

Figure 1a. Floor Components

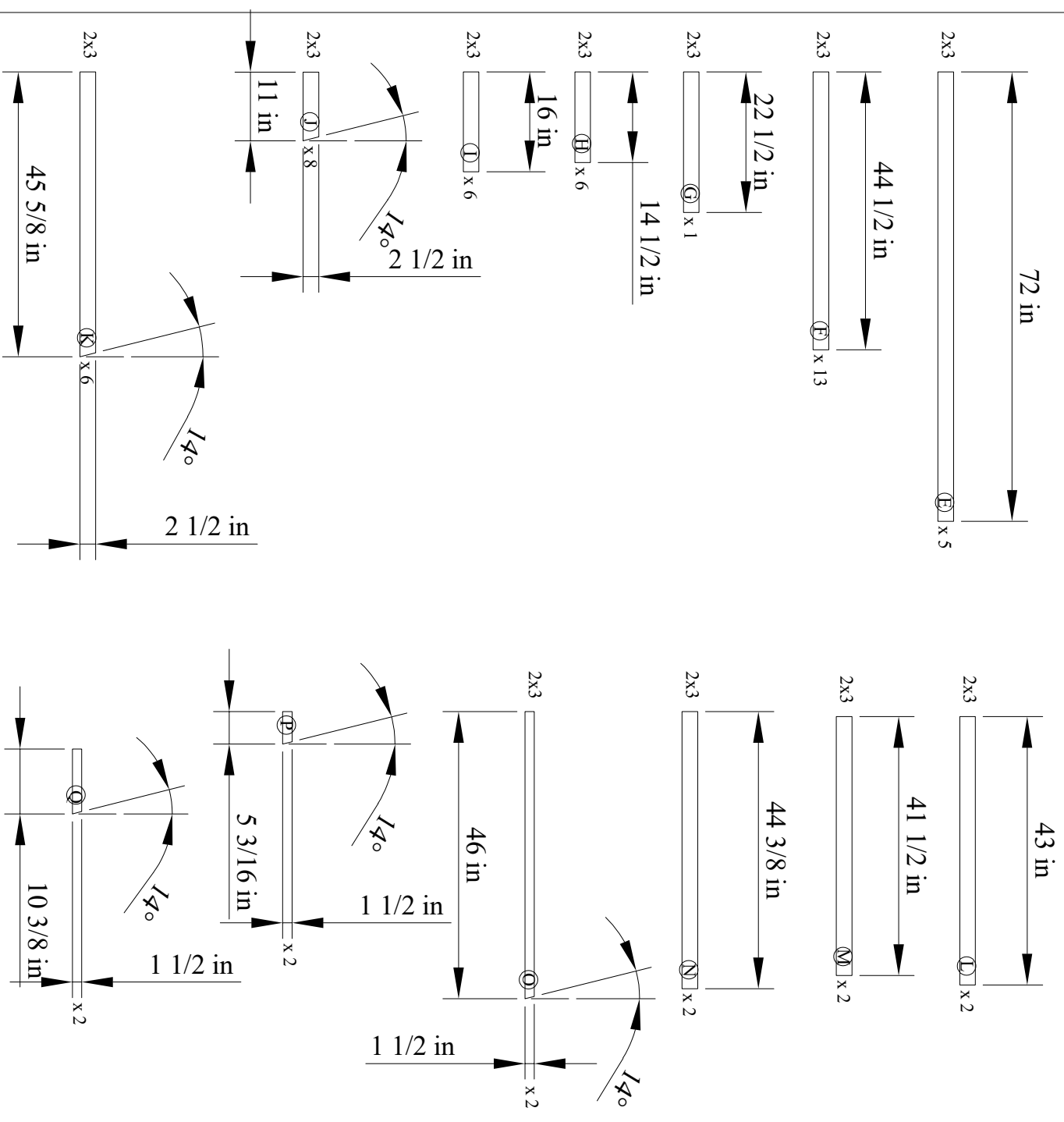

Figure 1b. Wall framing members

Design.	A (in.)	Number
T1	6	6
T2	14 1/2	6
T3	16	6
T4	21	4
T5	22 1/2	2
T6	27	2
T7	43	2

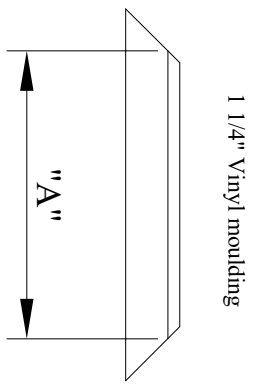

Figure 1d. Outside corner trim components

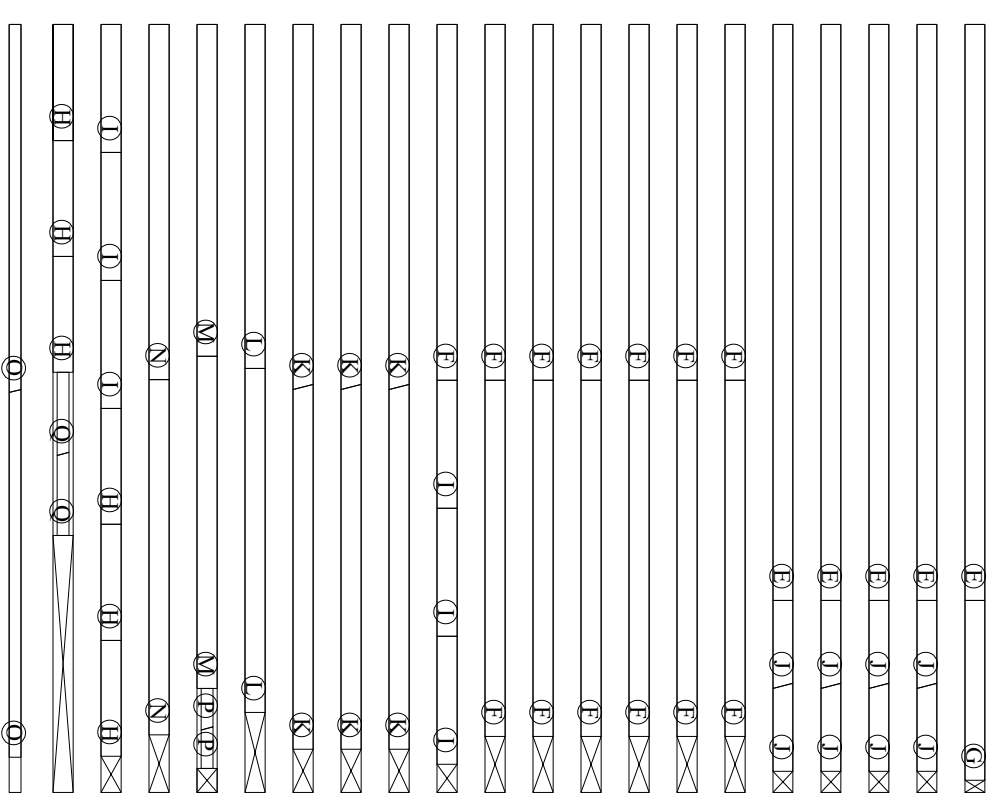
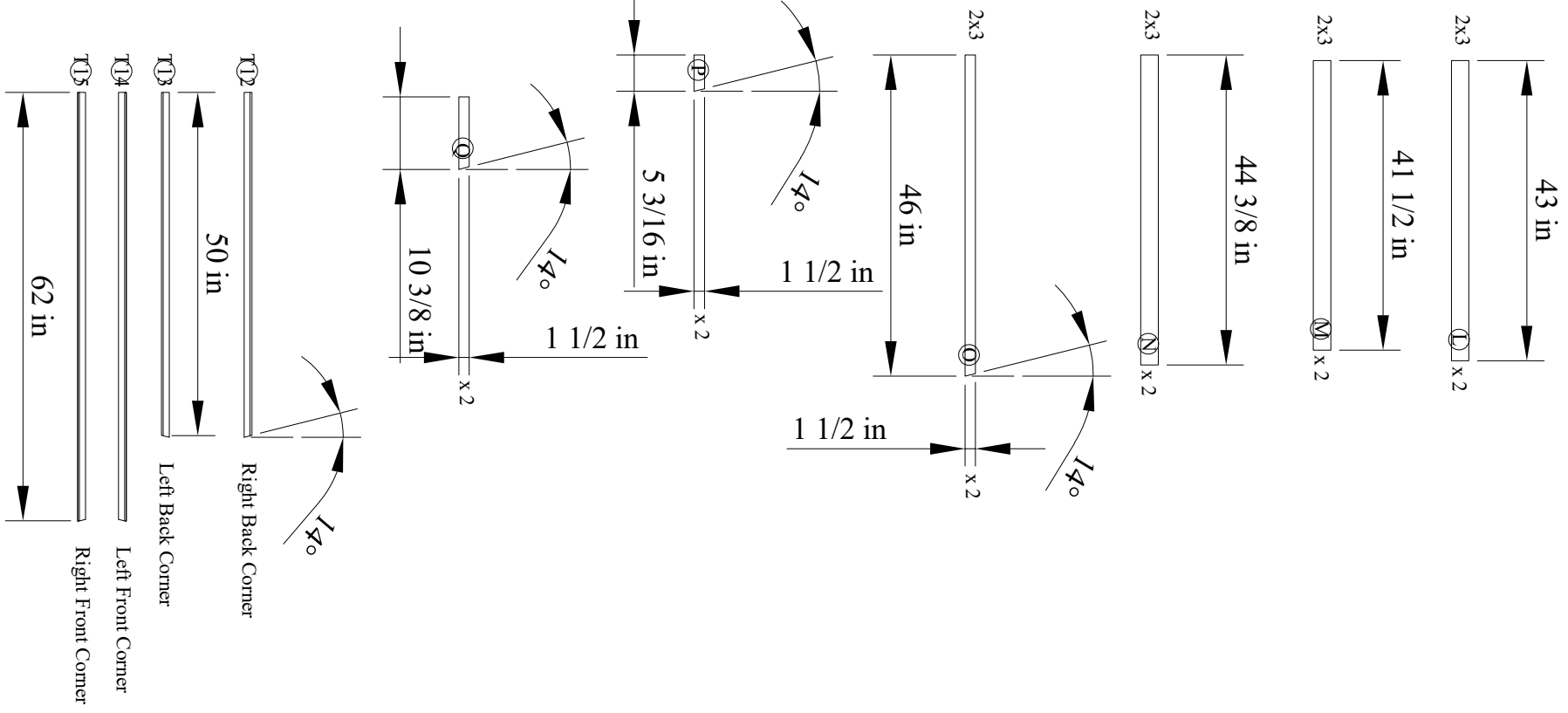

Figure 5. Cutting plan for wall framing

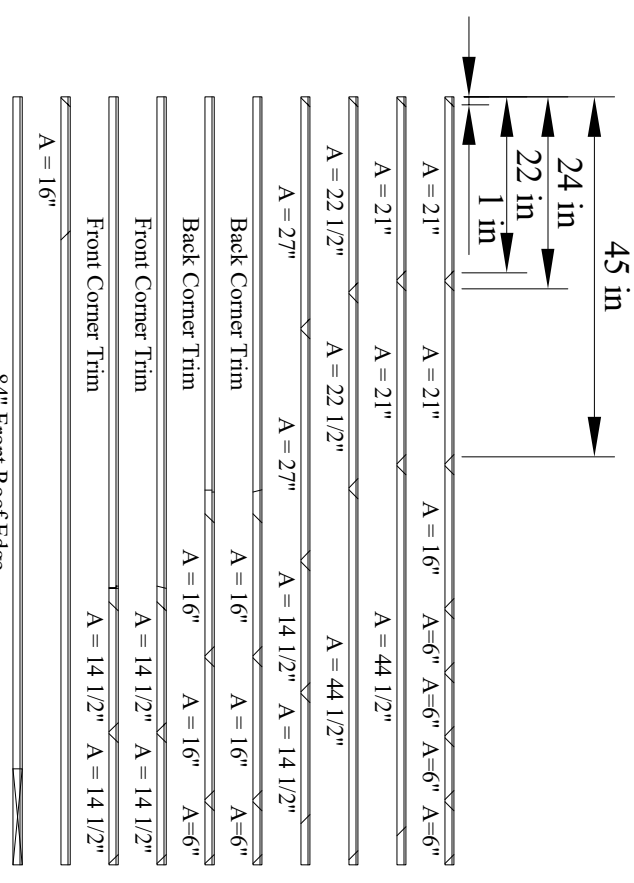

Figure 14a. Outside corner trim cutting plan

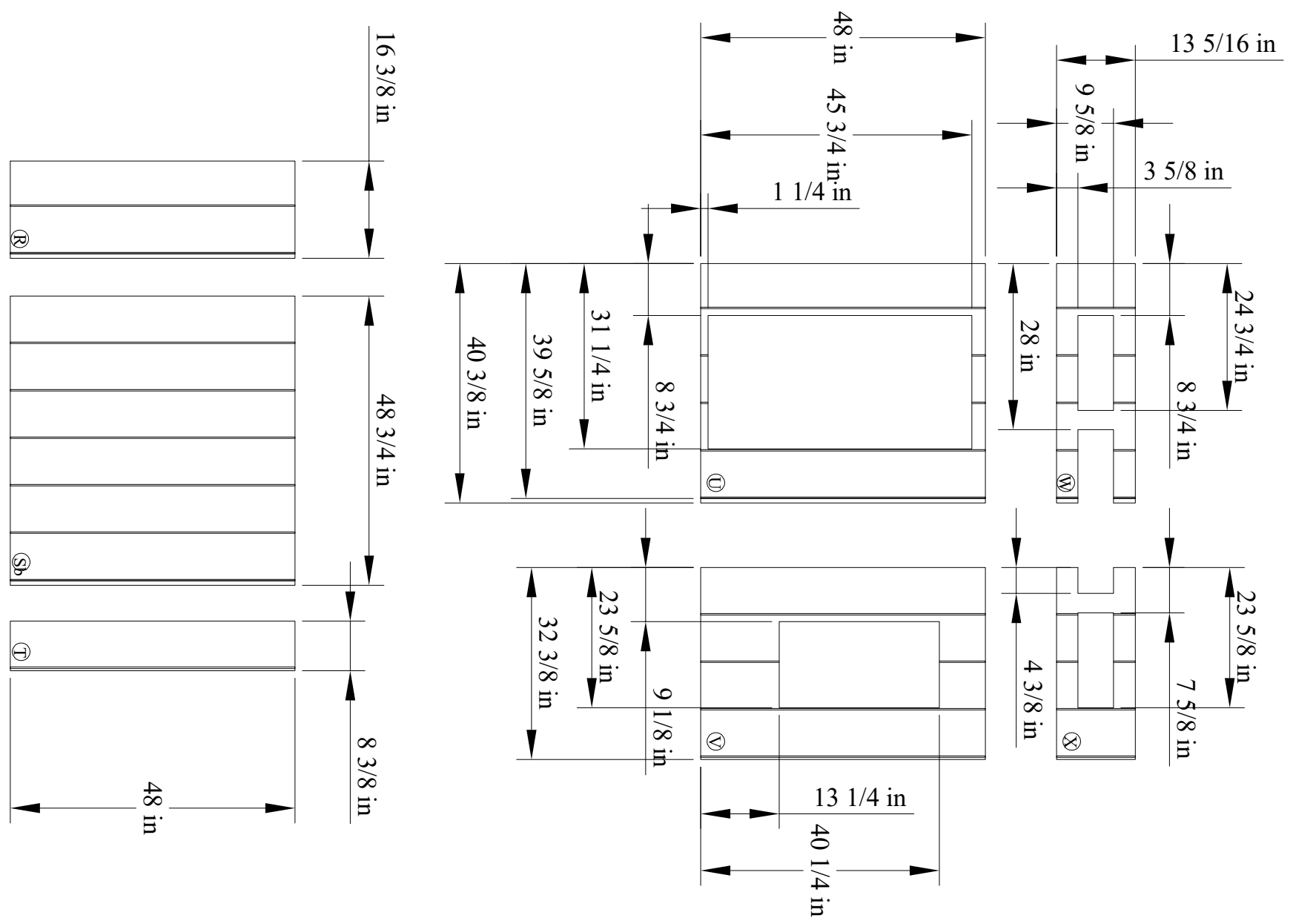

Figure 1c. Wall sheathing panels

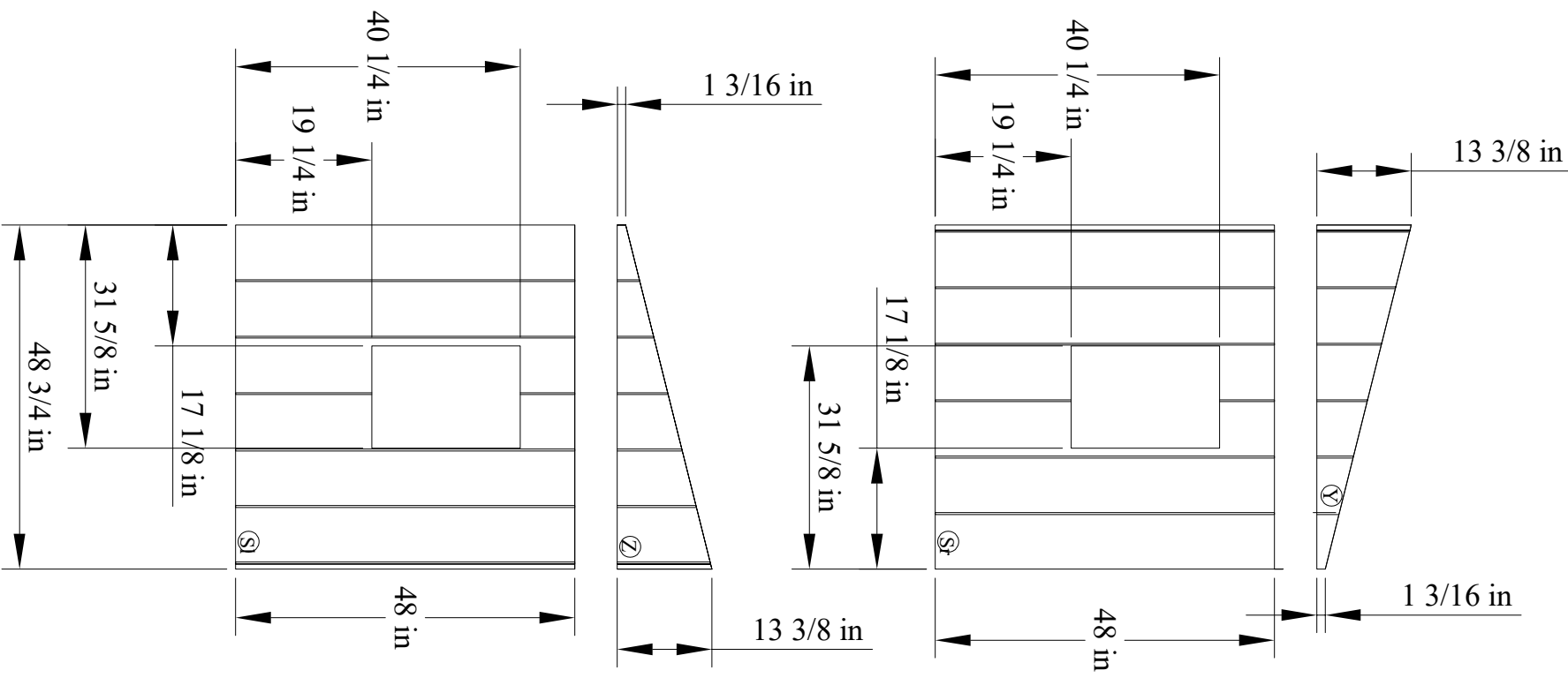

Figure 11. Cutting plan for the Front and Rear wall sheathing

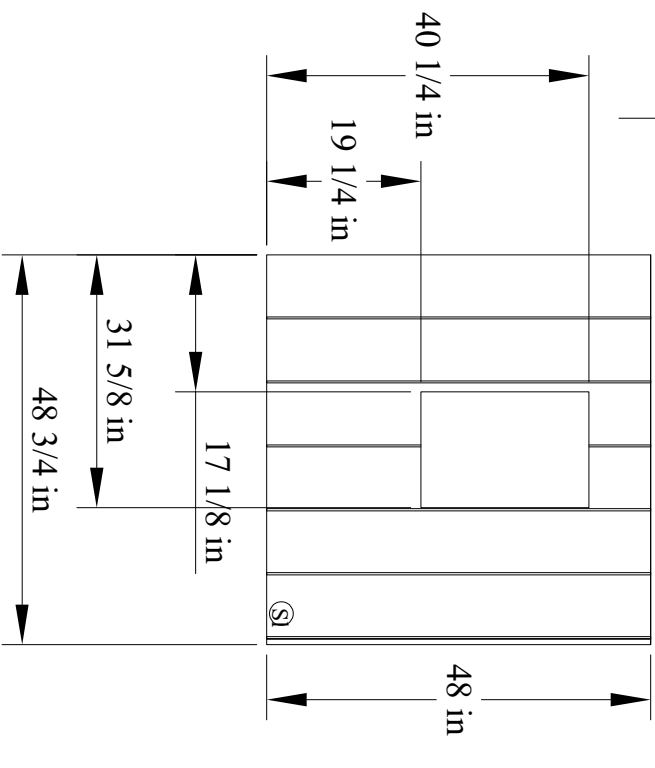
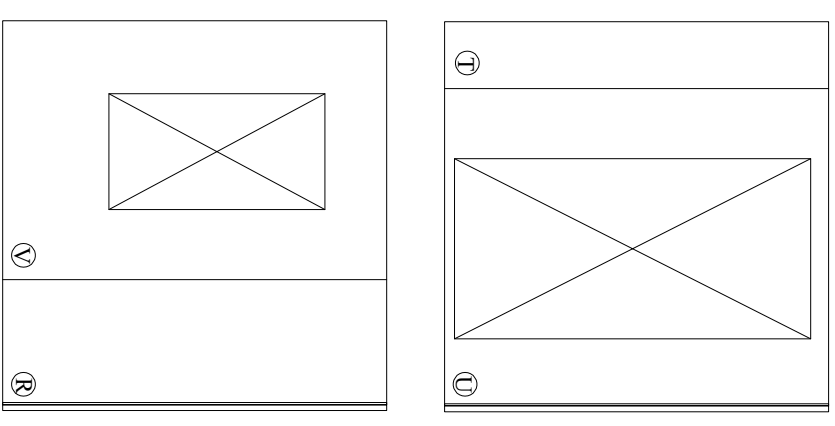
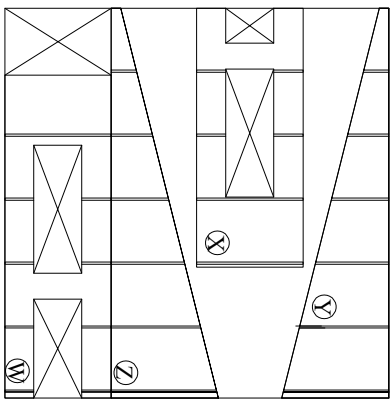

Figure 12. Cutting plan for the top portions of Front, Right and Left wall sheathing



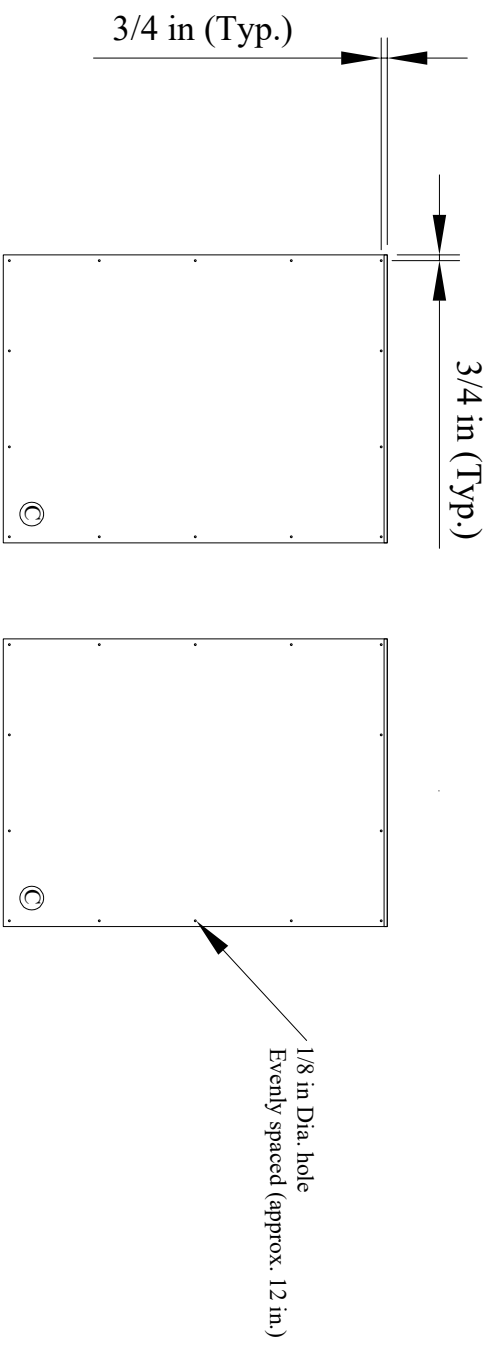

Figure 9. Floor drilling plan

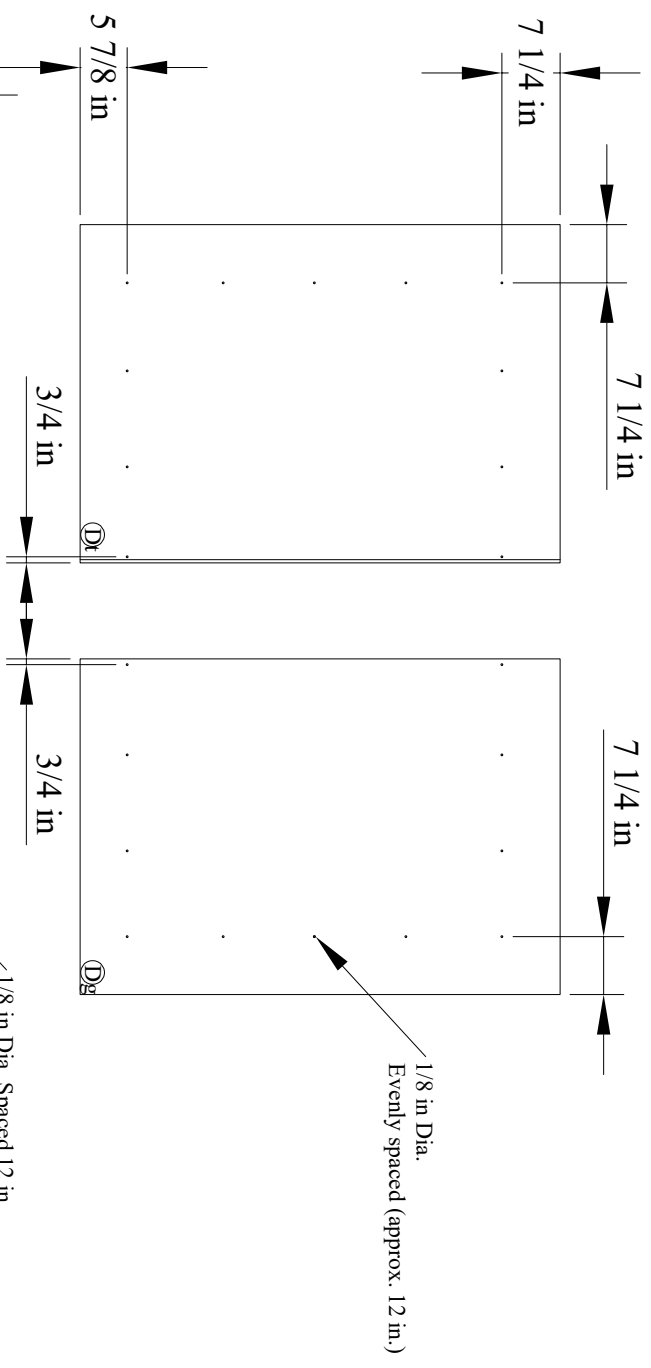

Figure 10. Roof drilling plan

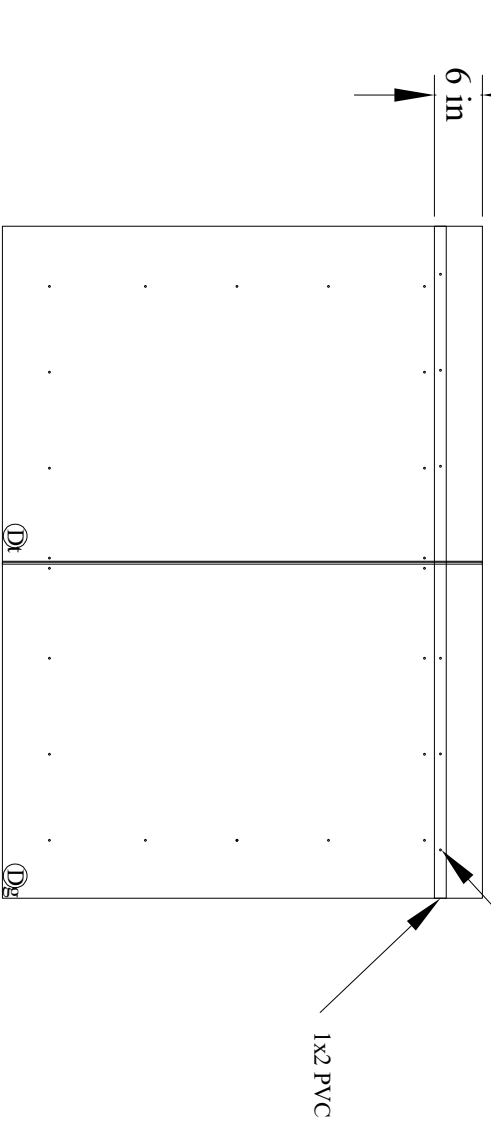

Figure 35. Roof assembly

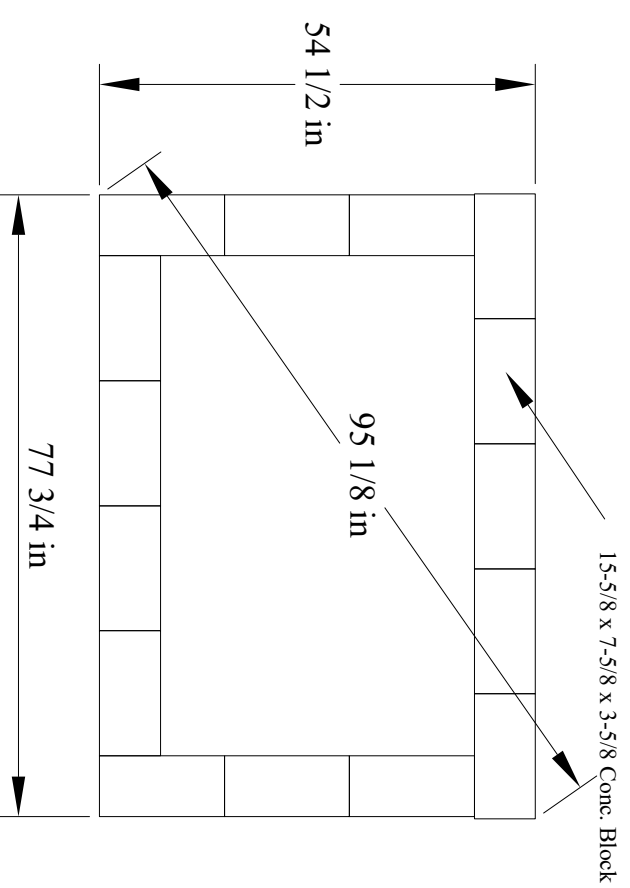

Figure 15. Concrete block foundation

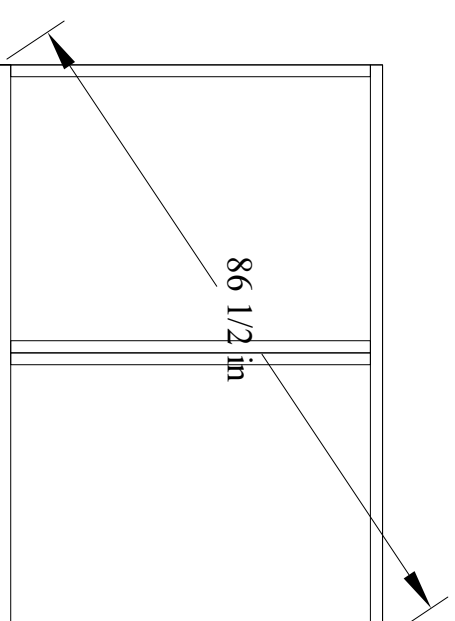

Figure 17. Floor framing assembly

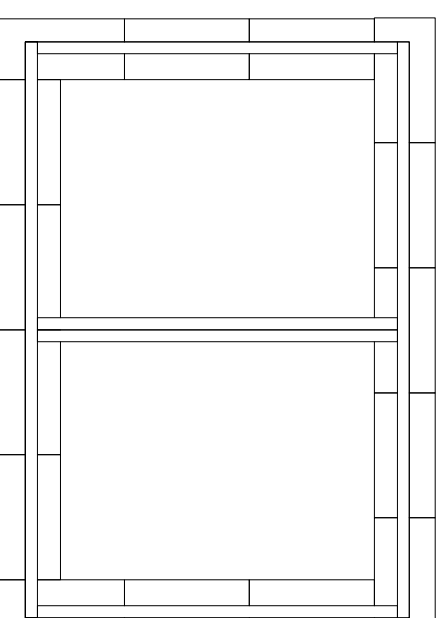

Figure 18. Floor placement on foundation

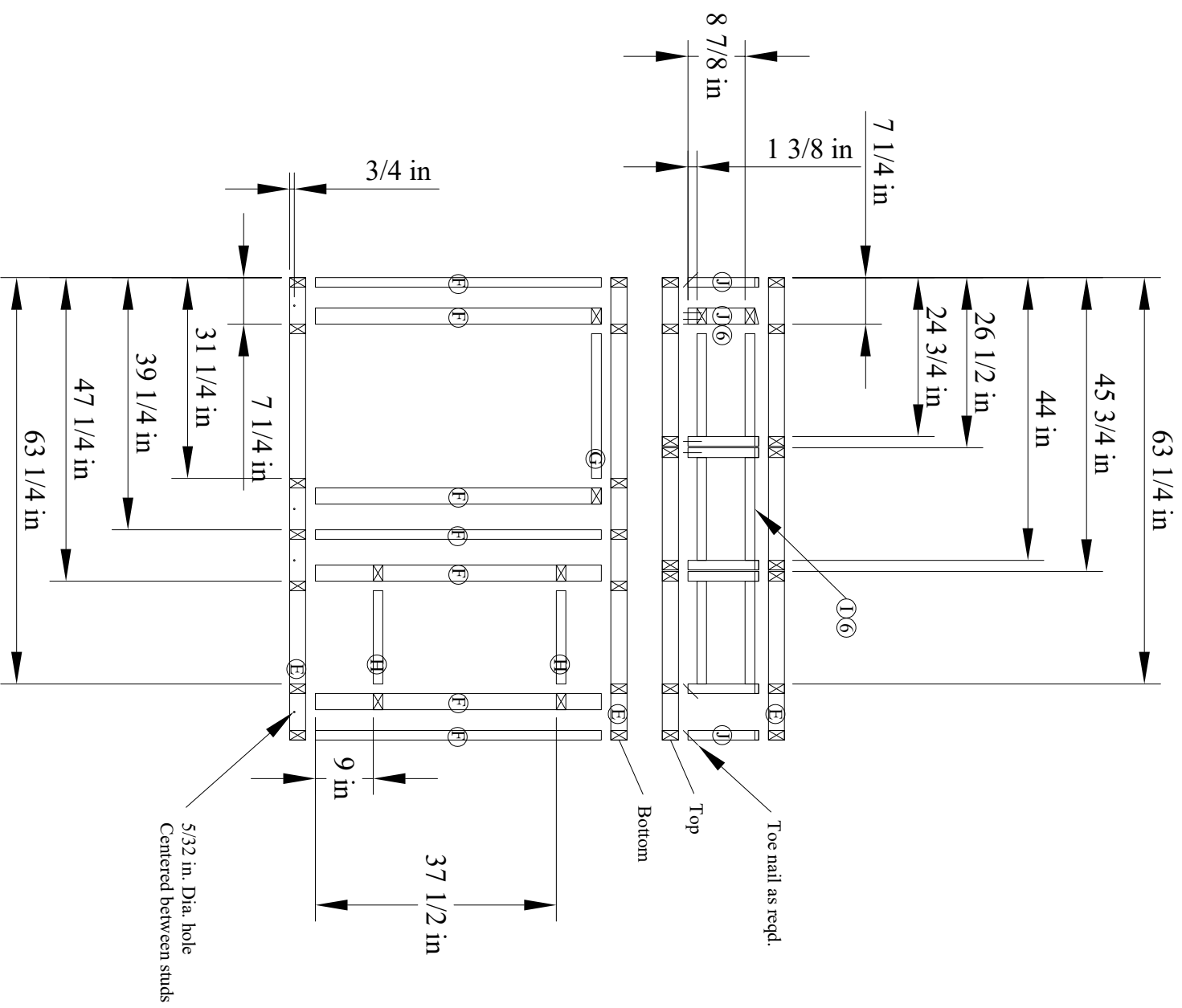

Figure 6a. Marking and drilling plan for Front Wall framing

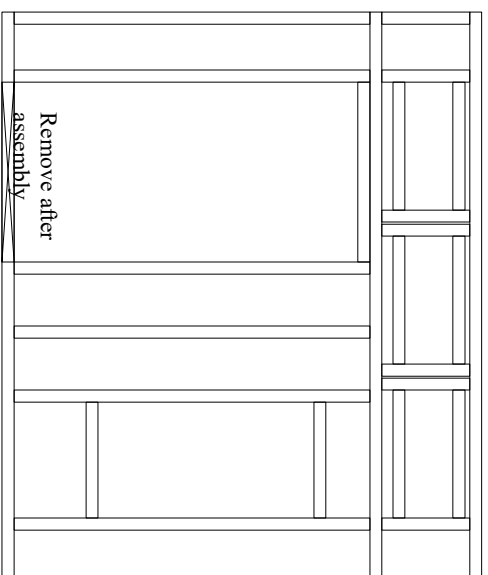

Figure 21a. Front wall framing assembly

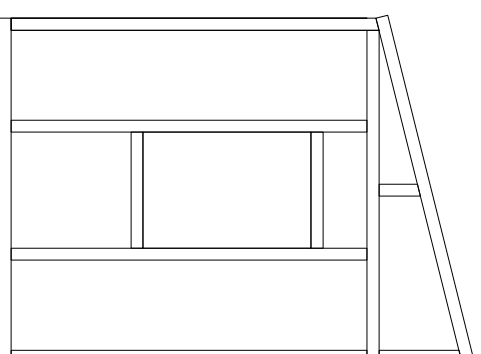

Figure 21d. Left wall framing assembly

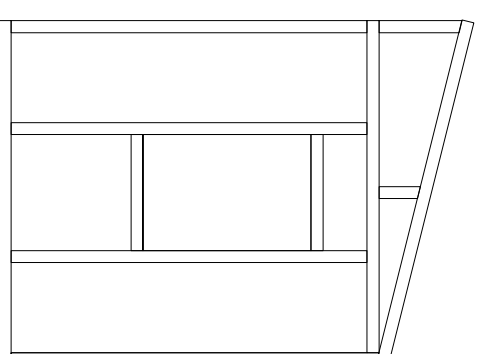

Figure 21c. Right wall framing assembly

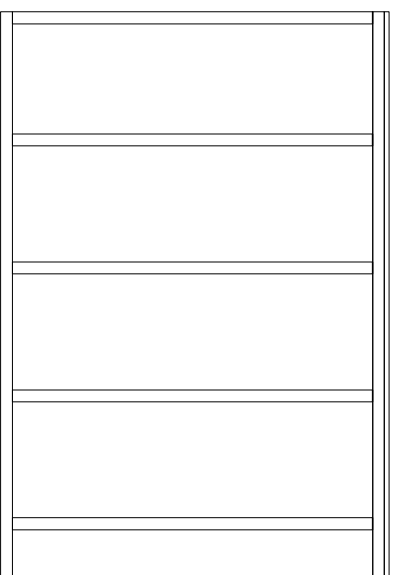

Figure 21b. Rear wall framing assembly

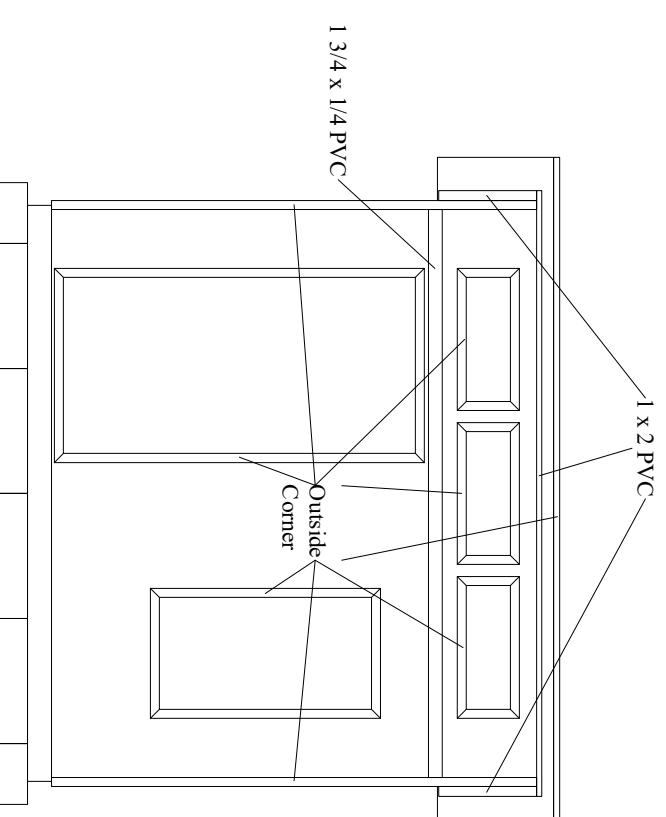

Figure 37. Front trim placement

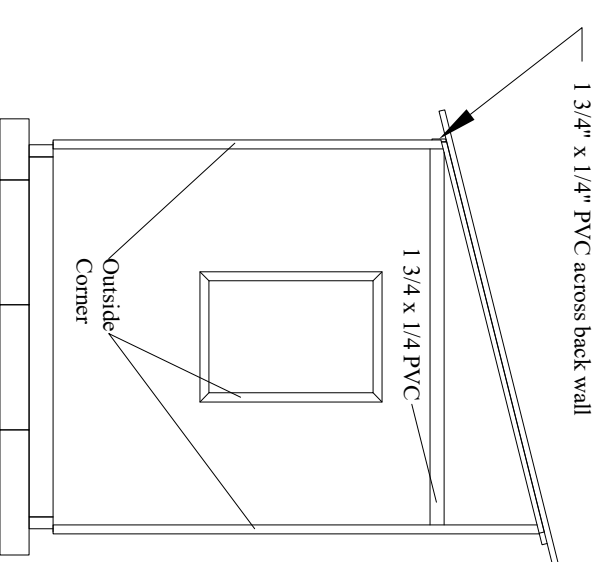

Figure 38. Side trim placement

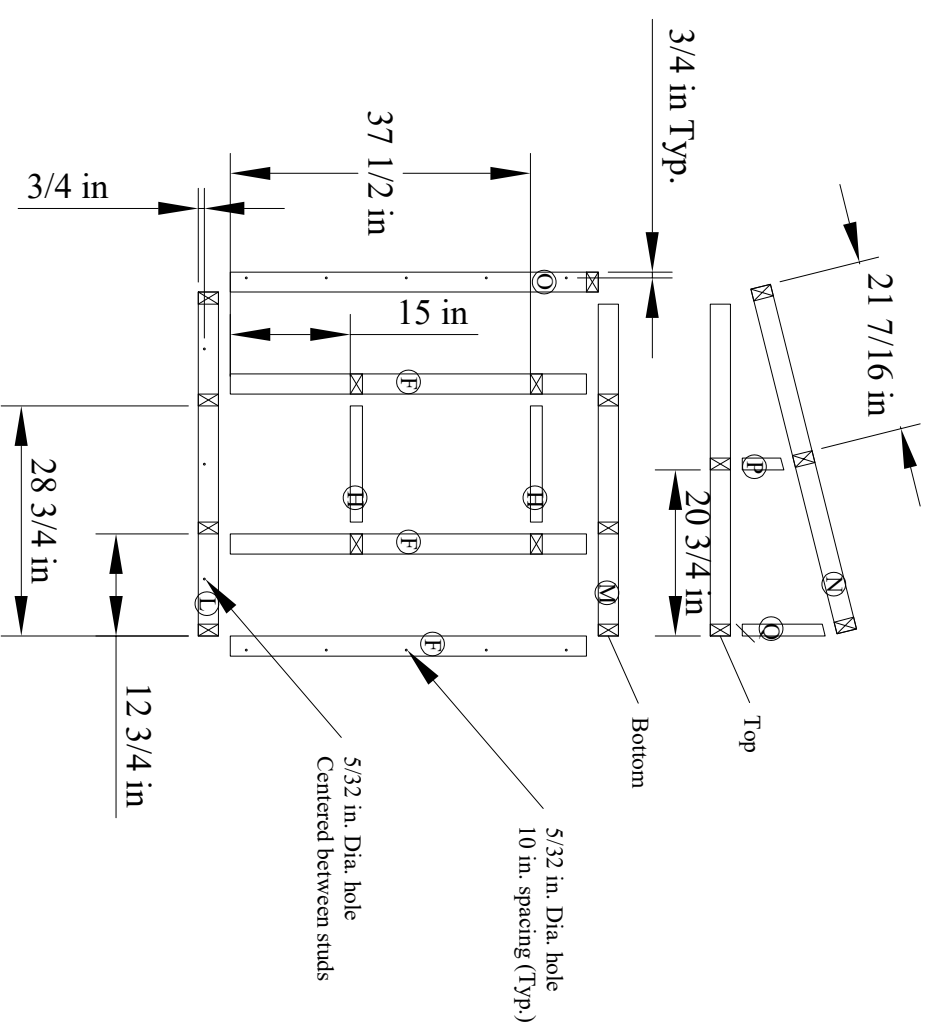

Figure 6d. Marking and drilling plan for Left Wall framing

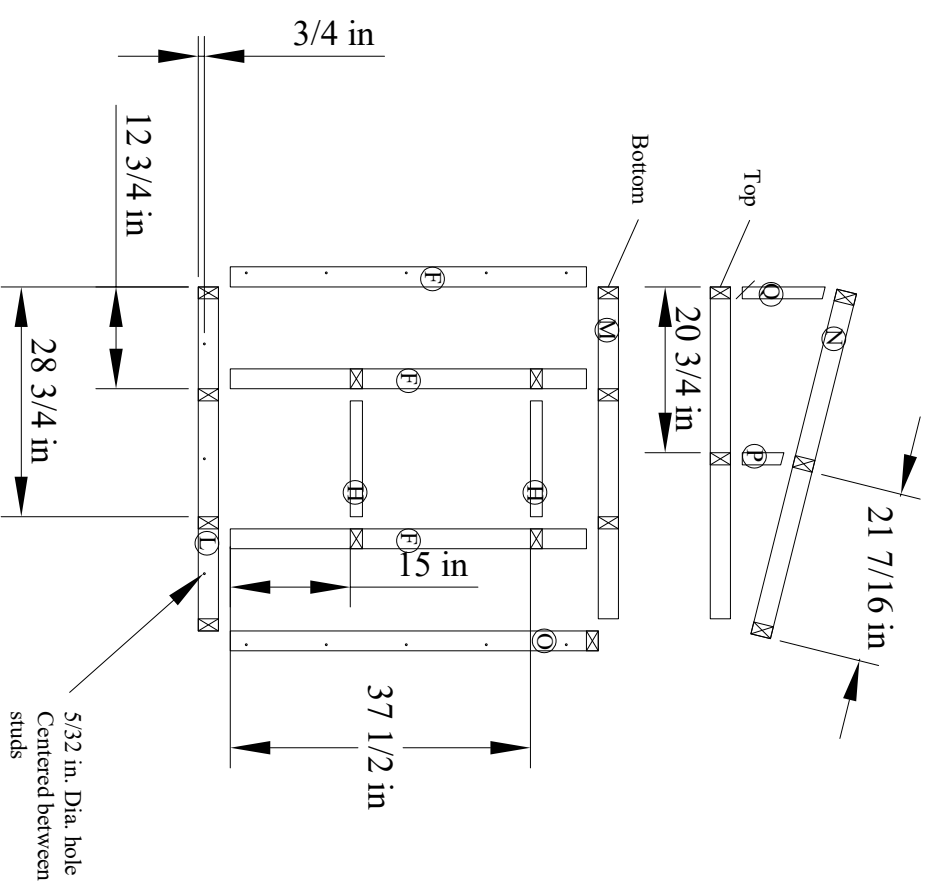

Figure 6c. Marking and drilling plan for Right Wall framing

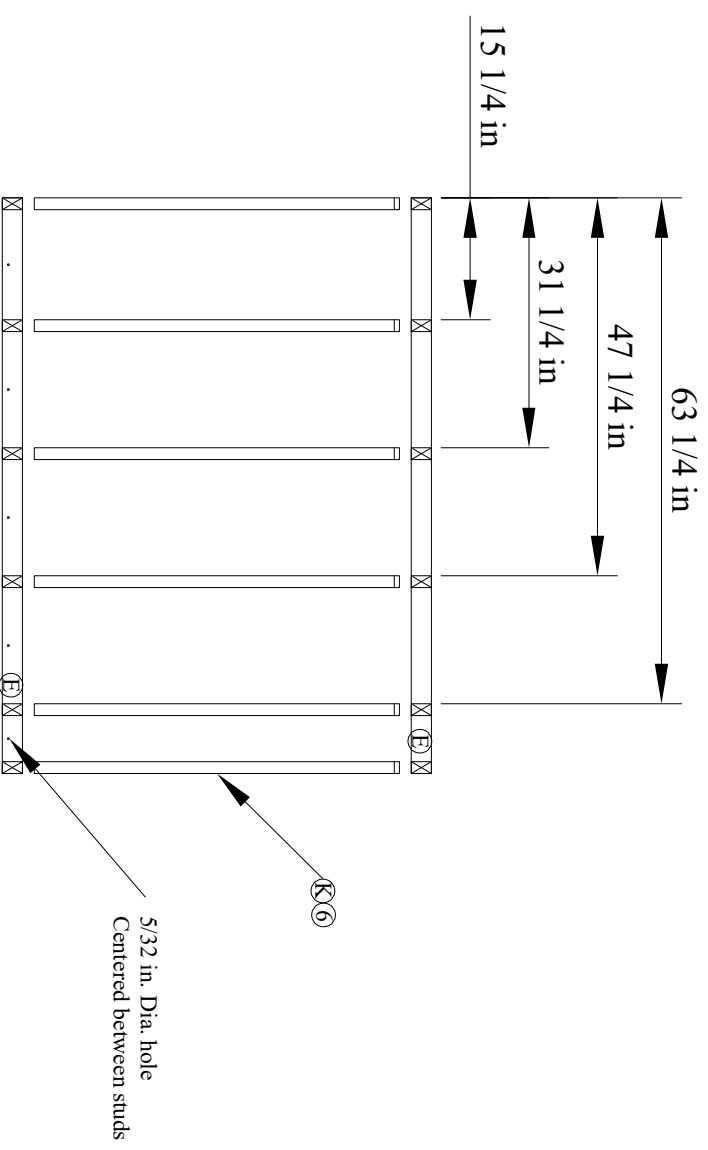

Figure 6b. Marking and drilling plan for Rear Wall framing

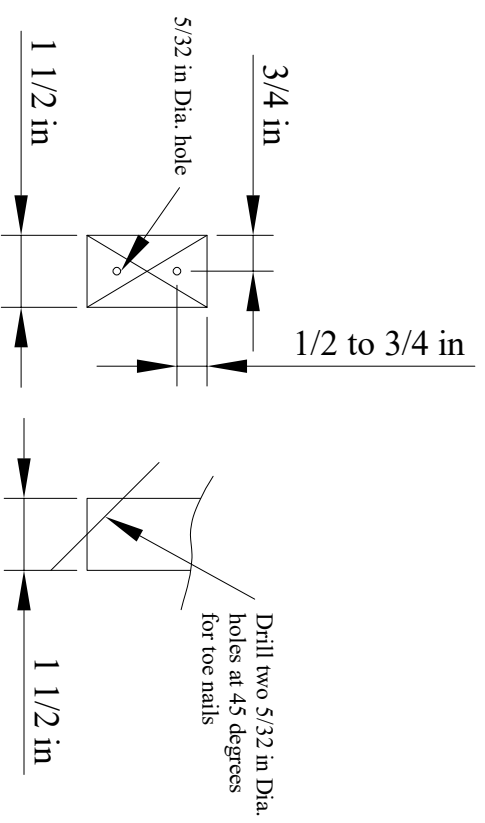

Figure 6e. Drilling key

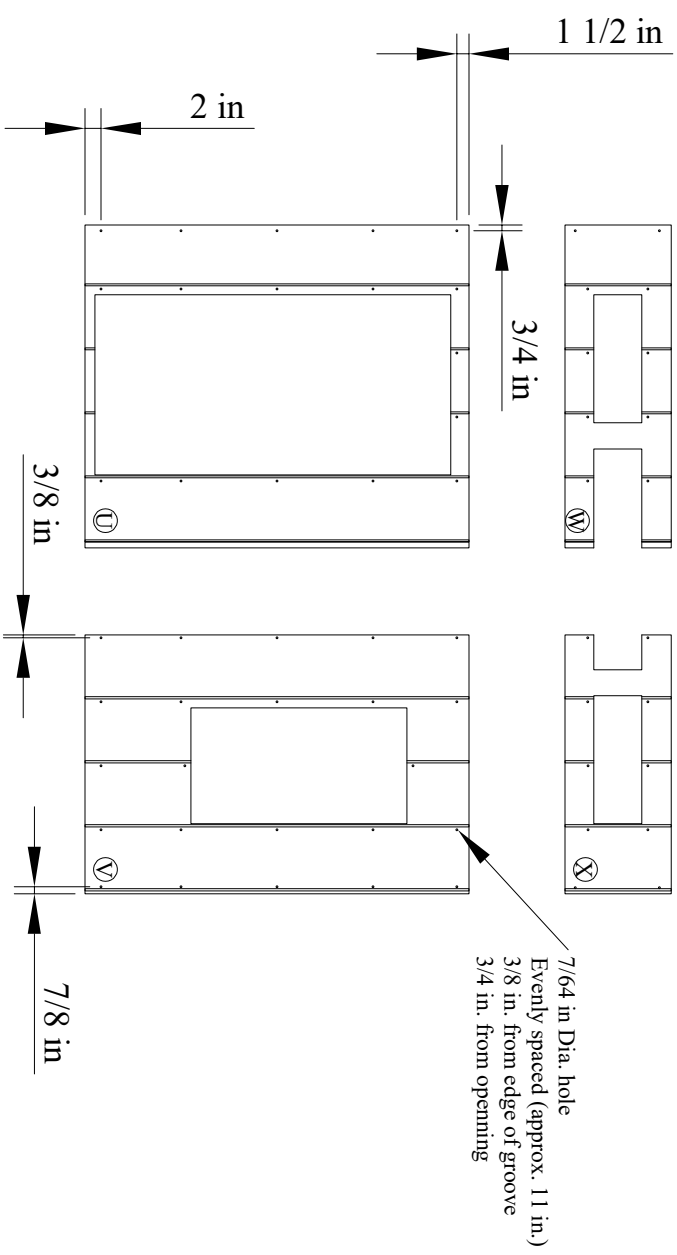

Figure 13a. Drilling plan for Front wall sheathing

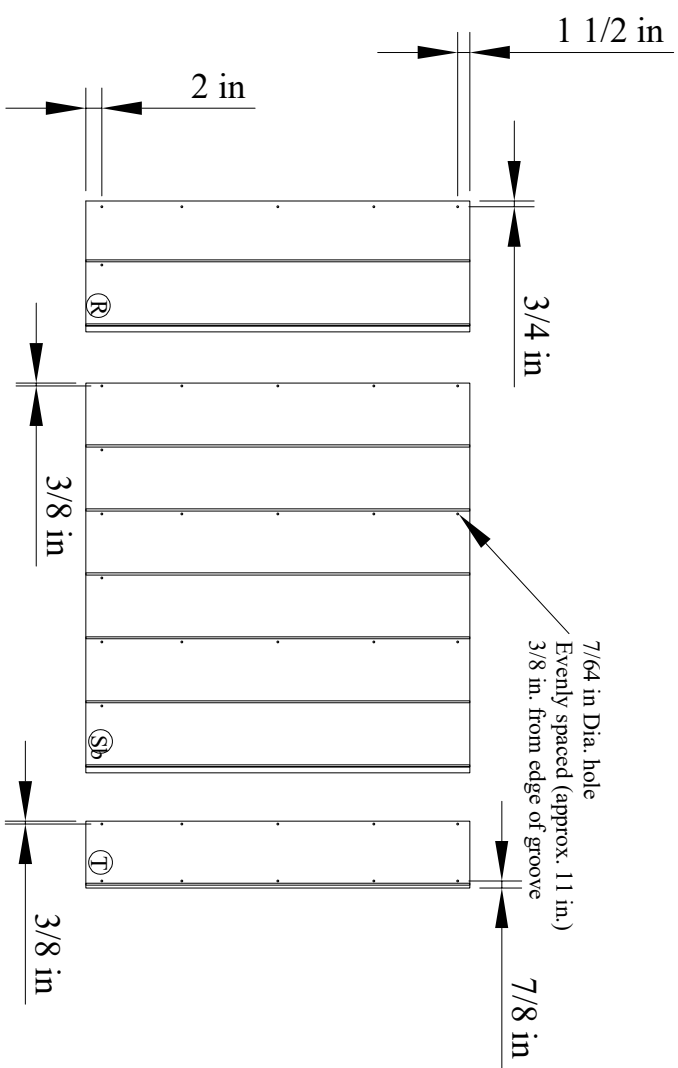

Figure 13b. Drilling plan for Rear wall sheathing

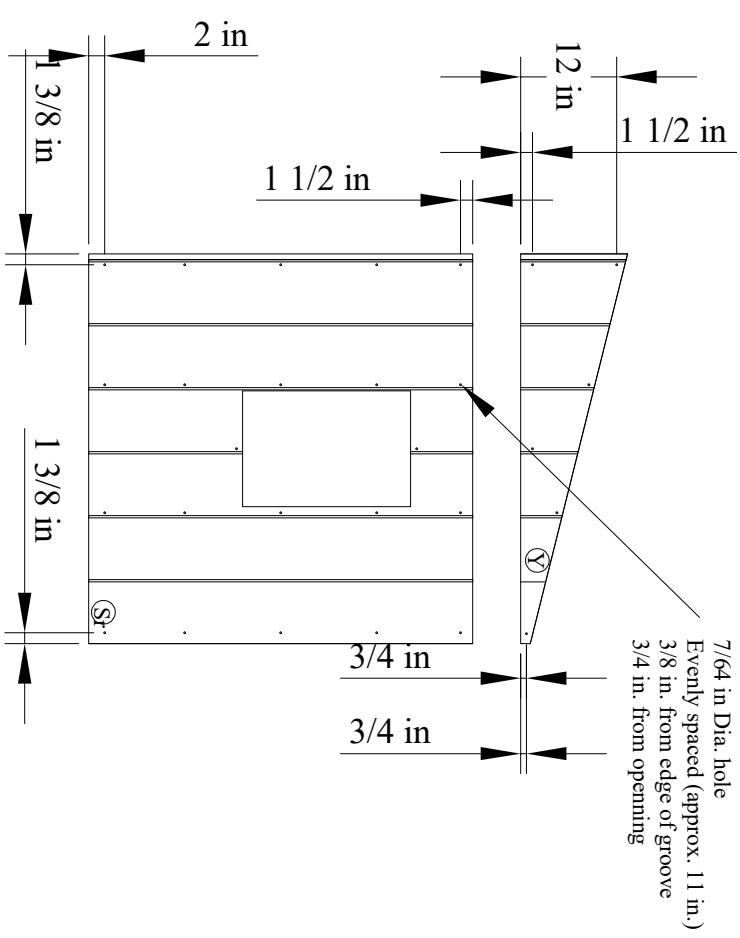

Figure 13c. Drilling plan for Right wall sheathing

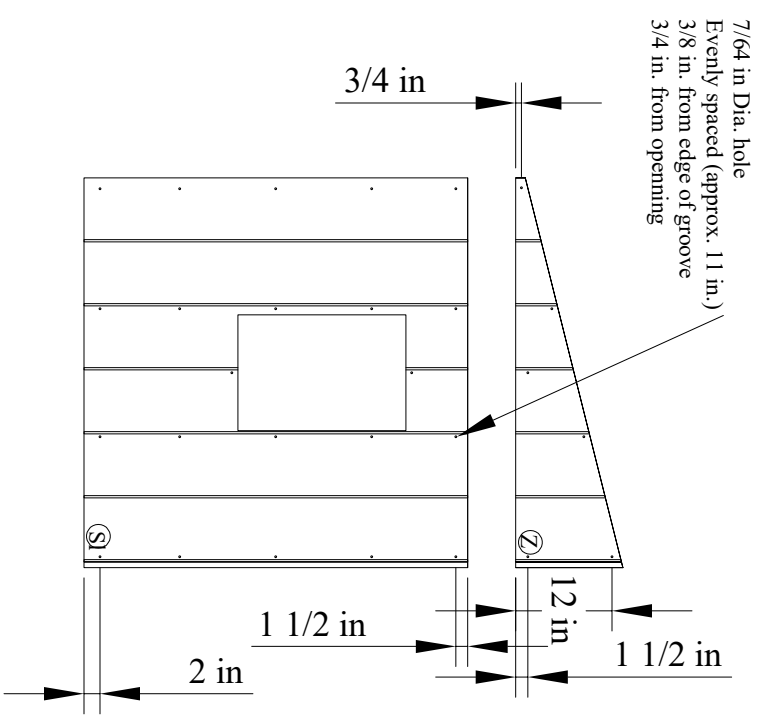

Figure 13d. Drilling plan for Left wall sheathing